



# 目 录

<b>一、运输作业组织与管理模块</b> .....	<b>2</b>
.....	2
.....	5
.....	10
.....	13
.....	16
.....	1
.....	22
.....	24
.....	30
<b>二、仓储与配送作业组织与管理模块</b> .....	<b>34</b>
.....	34
.....	40
.....	46
.....	52
.....	5
.....	63
.....	0
.....	6
.....	2
.....	4
.....	103
.....	10
.....	113
.....	11
.....	125
.....	131
.....	13
.....	143
<b>三、国际物流作业组织与管理模块</b> .....	<b>150</b>
.....	150
.....	152
.....	155
.....	15
.....	161
.....	164
.....	166
.....	16
.....	1 2

.....	1 5
.....	1
.....	1
.....	1 1
.....	1 4
.....	1
.....	1 0
.....	1 3
.....	1 5
.....	1
.....	1
.....	202
.....	204
.....	20
.....	20
.....	210
<b>四、 快递物流作业组织与管理模块.....</b>	<b>213</b>
.....	213
.....	216
.....	21
.....	224
.....	22
.....	231
.....	234
.....	23
.....	242
.....	246
.....	24
.....	252
.....	255
.....	25
.....	261
.....	264
.....	26
.....	2 1
.....	2 4
.....	2
.....	2 0
.....	2 3
.....	2
.....	2 0
.....	2 3

湖南商务职业技术学院物流管理专业学生技能考核题库

## 一、运输作业组织与管理模块

○

○

○

--	--	--

○

10000

4

6000

15

○

--	--	--	--	--



## ( ) 任务描述

○

:

○

○

4

10

5000

300000

15



○

20

/								
/								
				3				
<input type="checkbox"/> <input type="checkbox"/>				<input type="checkbox"/> <input type="checkbox"/>				
<input type="checkbox"/> <input type="checkbox"/>								
						<input type="checkbox"/> <input type="checkbox"/> <input type="checkbox"/> <input type="checkbox"/>		
	3							

○

15



( ) 任务描述:

- 
- 
- 

20

15









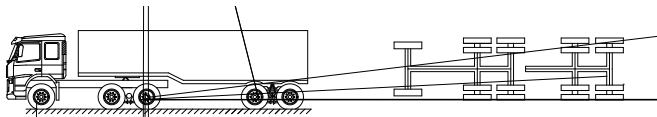

1 .5

1 .5



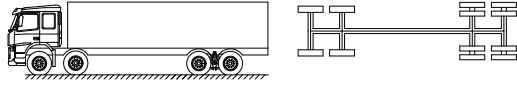

.6



.6

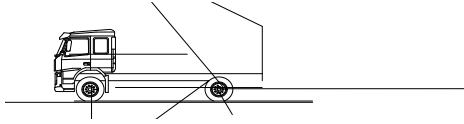

( ) 任务描述:







○

○

○

○

○



( ) 任务描述

○

15

○

1.65 /

34 /

4

10

25 /

12

250 /

20

○

20

**D**

/									
/									
*	*	*	*	*	3	*	*	*	
<input type="checkbox"/> <input type="checkbox"/>				<input type="checkbox"/> <input type="checkbox"/>					
<input type="checkbox"/> <input type="checkbox"/>									
*						<input type="checkbox"/> <input type="checkbox"/> <input type="checkbox"/> <input type="checkbox"/>			
	3								

○

15

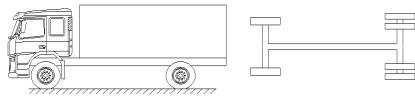
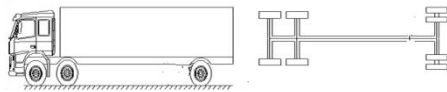
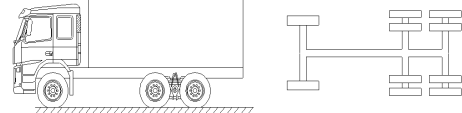
	1	4 2	
			
			

○

10

**2**

**3**

60

**4**

2

100

20%

0%

1



( ) 任务描述

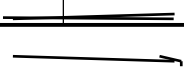

1 4 2



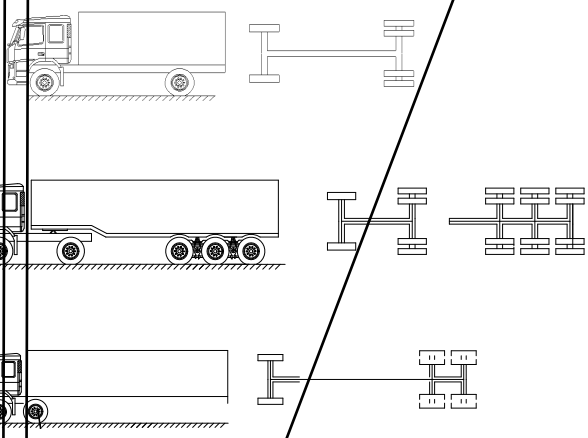





**( ) 任务描述**

- 
- 
- 
- 
- 





**( ) 任务描述**

HF

1

GUANGZHOU HF Trading CO., LTD.  
Room 502, No.838, Dongfeng Road, Guangzhou, China  
TEL: 020-87656751 FAX: 020-87656772

2

AL QADAH TRADING COMPANY L.L.C  
202 W. 1st St. LOS ANGELES, CA 90012  
Phone (877) 554-4000 Fax (213) 237-3535

3

PRODUCT: CLEANING BALL  
PARTIAL SHIPMENT                    allowed  
TRANSSHIPMENT                    : allowed

&	(CARTONS)	(CBM)			
	3500	53 21 15 0.016 3/	12 /	11 /	1000

4 TIME OF SHIPMENT ( ) 2016 5 15

5 SERVICE TYPE ( ) CY/CY

6 FREIGHT ( ) PREPAID

7 PORT OF LOADING ( ) SHENZHEN

8 PORT OF DISCHARGE ( ) LOS ANGELES

9

USD1450/20GP, USD1800/40GP, USD1800/40HQ

	100/20      150/40 150/40	
	1 0/20      310/40 310/40	
	3 4/20 /40 /40	
	25/	
	50/	
	50/20 30/40 30/40	
	30/20 30/40 30/40	



*SHIPPER : (      )	/			
	*			
	*	*		
	*			
*CONSIGNEE	* /			
	*			
NOTIFY PARTY:			-	
* /	*	*	*	*

MARK NUMBERS										DESCRIPTION OF GOODS										KGS		KGS		CBM			
√																											
*	√	CY/CY √								CFS/CY																	

○

Sailing Schedule from : Shenzhen,Shenzhen,Guangdong,China	
To : Los Angeles,Los Angeles,CA,United States	
Origin City : Shenzhen,Shenzhen,Guangdong,China	CY/DOOR
Destination City : Los Angeles,Los Angeles,CA,United States	CY/DOOR

序列号	航线	船名	航次	截关时间	装货港	预计离港时间	实际离港时间	卸货港
1	YPSW	YM UNISON	59E	2016-04-22 17:00	Yantian	2016-04-25		Los Angeles
2	SEA	NORTHERN JAVELIN	002E	2016-04-23 12:00	Yantian	2016-04-27		Long Beach
3	AAS2	CMA CGM LIBRA	095TXE	2016-04-25 16:00	Yantian	2016-04-28		Long Beach
4	YPSW	YM UBIQUITY	22E	2016-04-29 17:00	Yantian	2016-05-02		Los Angeles
5	SEA	C SCL PUSAN	117E	2016-04-30 12:00	Yantian	2016-05-04		Long Beach
6	AAS2	CMA CGM COLUMBA	097TXE	2016-05-02 16:00	Yantian	2016-05-05		Long Beach
7	SEA	COSCO NINGBO	069W	2016-05-06 11:00	Yantian	2016-05-08		Long Beach
8	YPSW	YM JIREBY...	50E	2016-05-06 17:00	Yantian	2016-05-09		Los Angeles
9	SEA	COSCO EXCELLENCE	027E	2016-05-07 12:00	Yantian	2016-05-11		Long Beach
10	AAS2	CMA CGM CENTAURUS	099TXE	2016-05-09 16:00	Yantian	2016-05-12		Long Beach
11	YPSW	YM MASCULINITY	32E	2016-05-13 17:00	Yantian	2016-05-16		Los Angeles
12	SEA	HONG KONG BRIDGE	039E	2016-05-14 12:00	Yantian	2016-05-18		Long Beach
13	AAS2	CMA CGM THALASSA	101TXE	2016-05-16 16:00	Yantian	2016-05-19		Long Beach



干货箱



	箱体内部尺寸			箱体内容积及载重量		箱门开度尺寸	
	L	W	H	Cu	P	W	H
20'	5898	2352	2393	33.2	21740/28230#	2340	2280
40'	12032	2352	2393	67.7	26630	2340	2280
HC	12032	2352	2698	76.3	26520	2340	2585

冷藏箱



	箱体内部尺寸			箱体内容积及载重量	
	L	W	H	Cu	P
20'	5444	2284	2267	28.5	21135/27160#
40'	11583	2284	2250	58.7	26580
HC	11583	2284	2659	67.9	26380

开顶箱

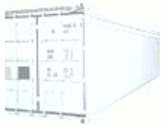

	箱体内部尺寸			箱体内容积及载重量	
	L	W	H	Cu	P
20'	5900	2330	2337	32.6	21740
40'	12025	2330	2337	65.8	26410

○

○

( ) 实施条件

( ) 考核时量

60

( ) 评分细则

		20%	2	0%	100
1		1			
( 0 )		20			
		10		5 5	
		15		3 2 3 2	2
		20		3 5	



				10 5	
		15			5 10

( ) 任务描述

( )

2014 10 20 00  
60 50 40 10 / 16000 /  
5

	-45	+45	+100	+300	+500	+1000
500	32	23	1	1	1	16



* ( )			
*			
	*	* <input type="checkbox"/> <input type="checkbox"/>	<input type="checkbox"/> <input type="checkbox"/>
*	( )		

*		*		*	
<input type="checkbox"/>	<input type="checkbox"/>				
<input type="checkbox"/>	<input type="checkbox"/>				
			( / / )		



”

( ) 实施条件

( ) 考核时量

60

( ) 评分细则

2 100  
 20% 0%  
 1  
 1



( 0 )		20			
		15		5	10
		15		10	5
		20		5	10 5
		10		10	

## 二、仓储与配送作业组织与管理模块

201 11

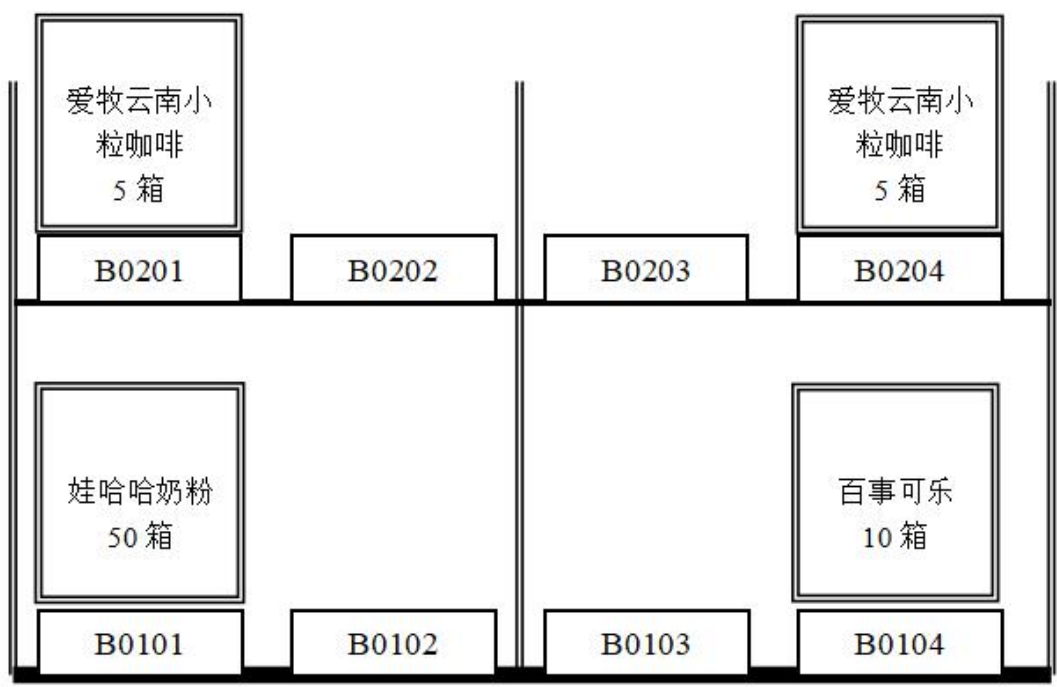
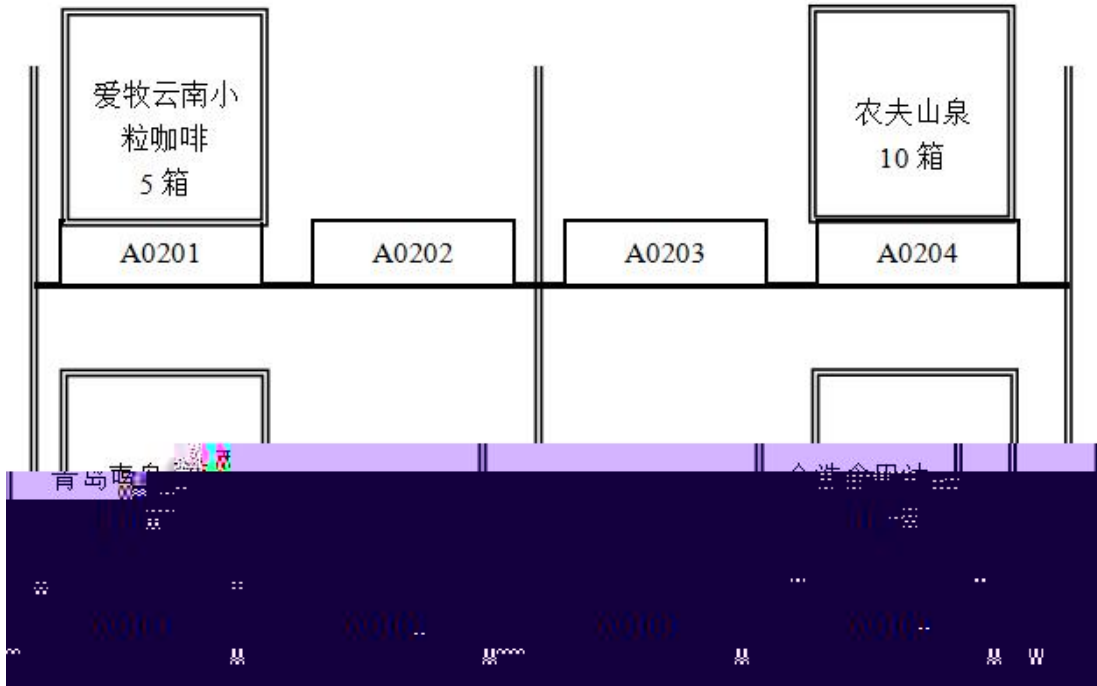

1 2



# 产品运输单

1011160001

			50	100 *5	50		
			40	310	40		
3			20	100	20		

- 
- 
- 
- 
- 
- 
- 
-



	1	
	2	1

	5		2	1
	10		2	0
	5		2	1
<b>80</b>	10		6	2
	10		4	3
	5		10	1
	5		5	
	5		3	
	5		2	3
			1	

	5		1	2	3	
	2			2		
			2	6	1	
	5		0.5	2	3	
	10		1	0.5	4	2
						30
	5					1
			1	0.5	4	3
						1
						150
	3					3



1 2

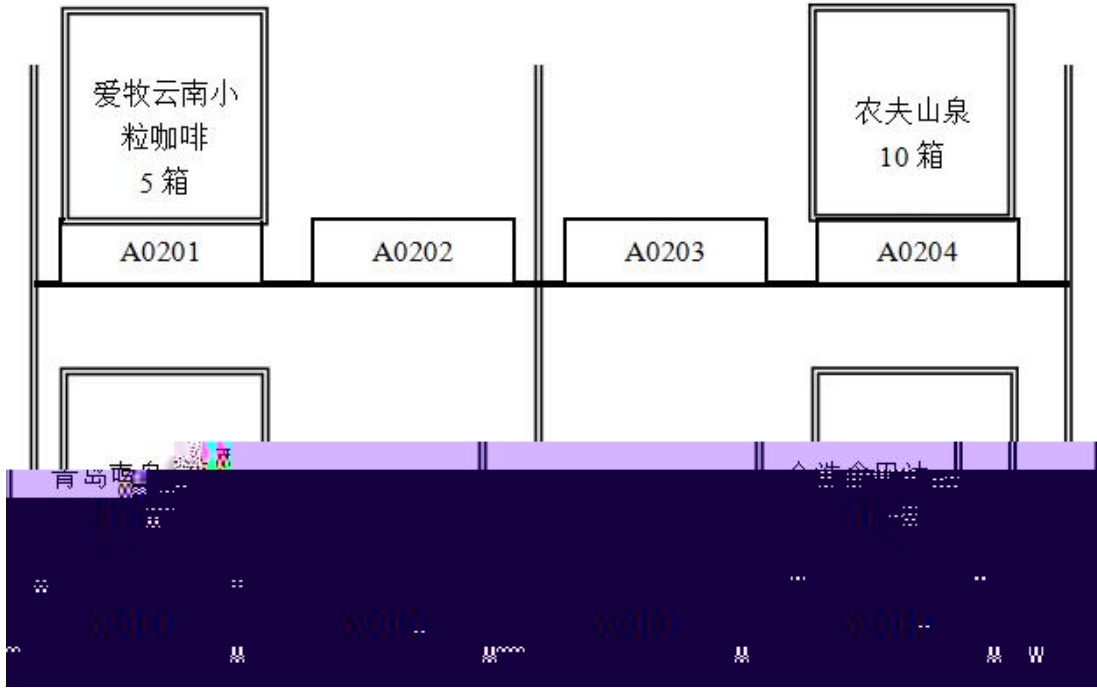

# 产品运输单

1011160001

				310	40		
			40		40		
3			20		20		

- 
- 
- 
- 
- 
- 
- 
- 

	1	

	2	1

		5		2	1
				2	
		10		1	2
				2	
		5		2	1
				2	
<b>80</b>		10		6	2
				4	
	10			10	3
				1	
	5			5	
	5			3	
	5			2	3
5			1		
			2		
			1	3	

		2		2		
				6 1 2		
	5			3 0.5 2		
		10		6 2 4 1 0.5 30		
			5		1	
				3 1 4 1 0.5 150		
		3		3		



2020 1



1 2

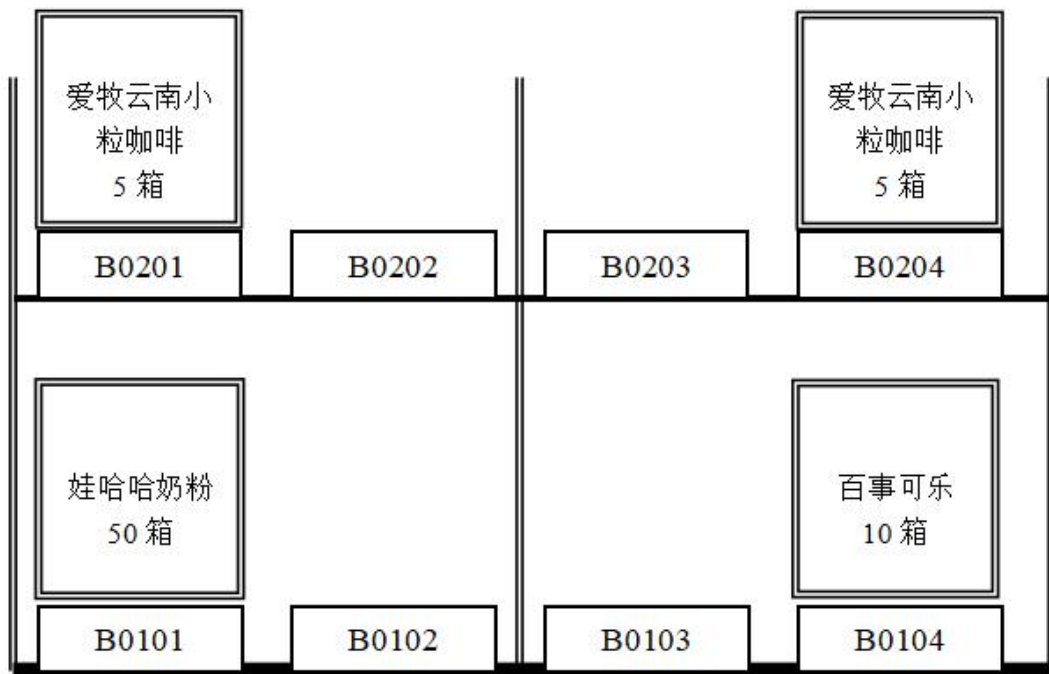
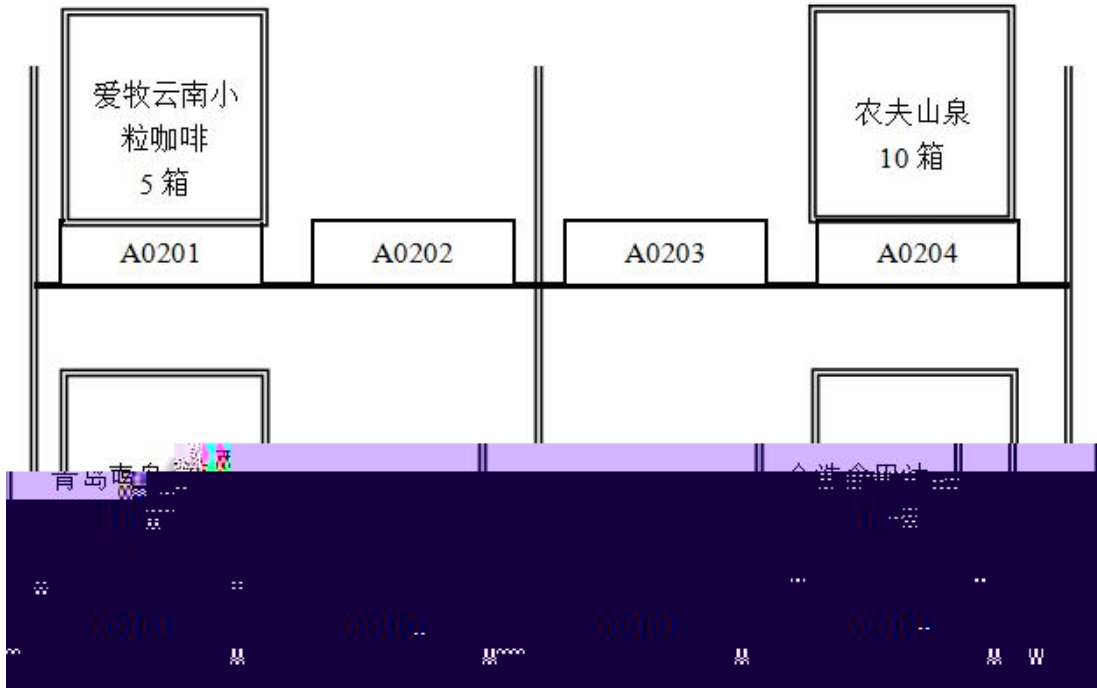

产品运输单

1011160001

			20	100 *5	20		
			40	100	40		
			40	330	30		

- 
- 
- 
- 
- 
- 
- 
- 
- 

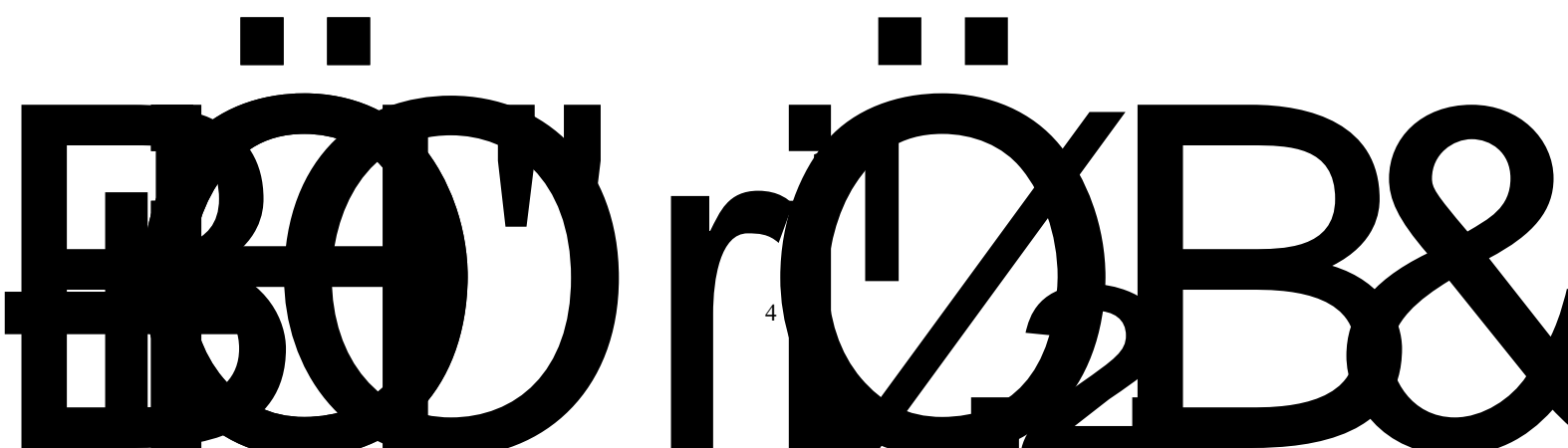

	2	1

	5		2	1
	10		2	
	5		2	1
<b>80</b>	10		6	2
	10		4	3
	5		1	
	5		5	
	5		3	
	5		2	3
	5		1	
	5		2	3
			1	
			2	
			3	
			0	

		2		2	
				6	1
				2	
		5		3	
			0.5	2	
				6	2
		10		4	
			1 0.5		30
		5			1
				3	1
				4	
			1 0.5		150
		3			3

1

2020 2



1 2



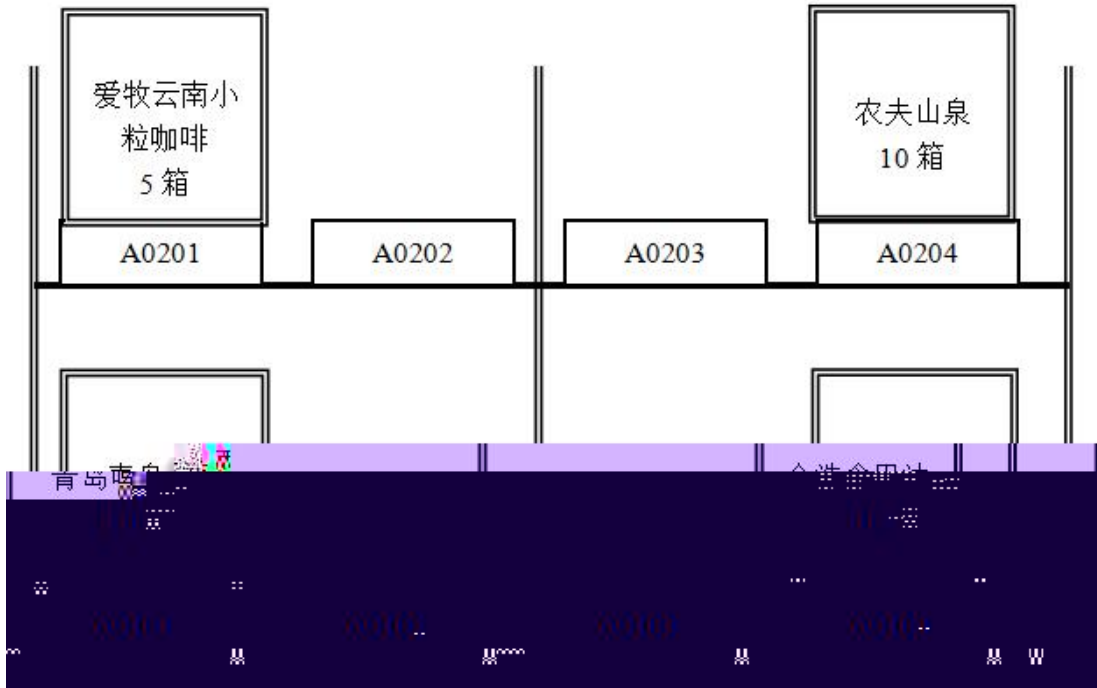

# 产品运输单

1011160001

			40	330	40		
			30	100 *5	30		
			30	310	30		

- 
- 
- 
- 
- 
- 
- 
- 

	1	

	2 1	

5 2 2 1  
2  
1  
2  
10 2  
1  
2  
2  
5 2 2 1 0  
2

		2		2	
				6	1
				2	
		5		3	
			0.5	2	
				6	2
		10		4	
			1 0.5		30
		5			1
				3	1
				4	
			1 0.5		150
		3			3

2020 4



1 2

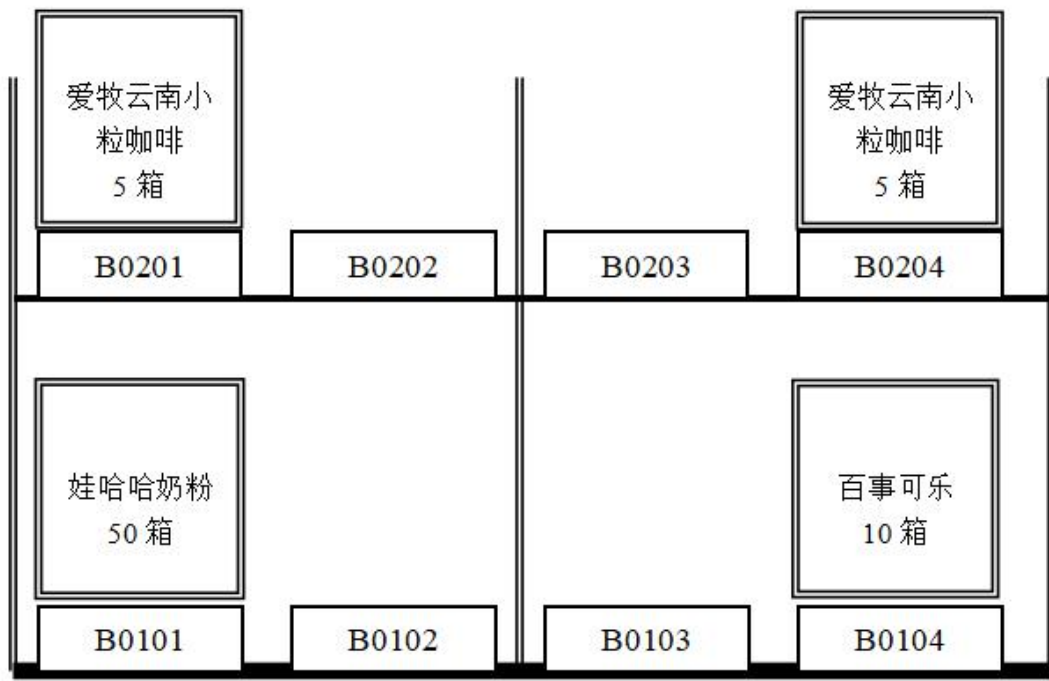
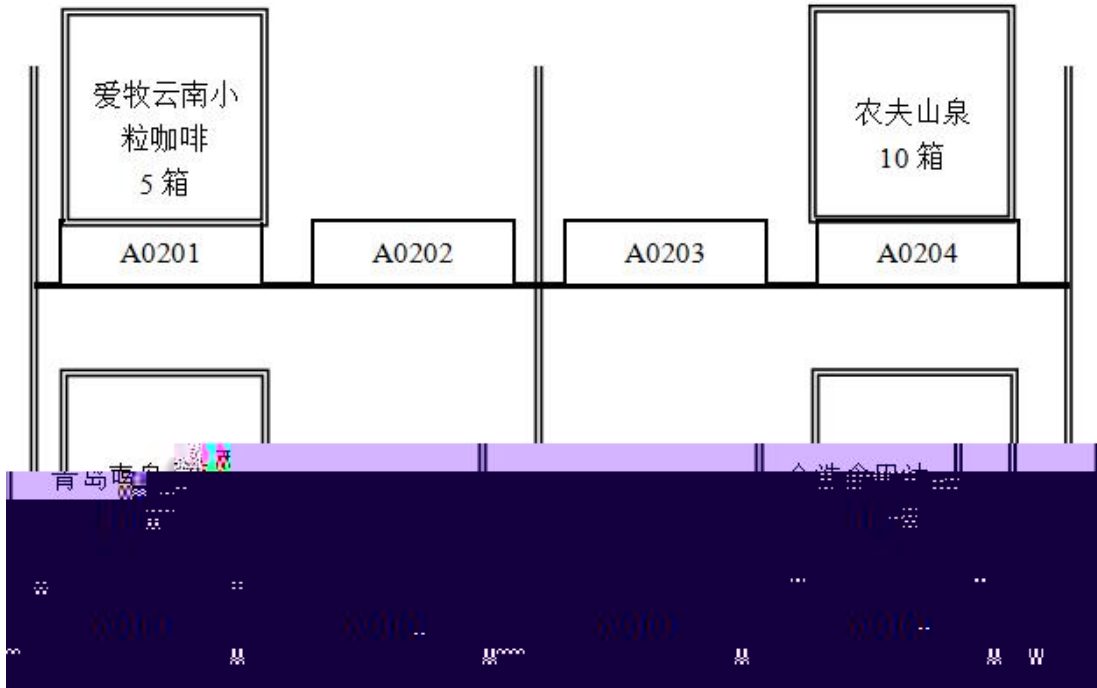

# 产品运输

10111 01

							7
			40	310	40		
			40	330	40		
3			20	100	20		

- 
- 
- 
- 
- 
-



	2	1

		5		2	1
				2	
		10		1	2
				2	
		5		2	1
				2	
<b>80</b>		10		6	2
				4	
	10			10	3
				1	
	5			5	
	5			3	
	5			2	3
5			1		
			2		
			1	3	

		2		2	
				6	1
				2	
		5		3	
			0.5	2	
				6	2
		10		4	
			1 0.5		30
		5			1
				3	1
				4	
			1 0.5		150
		3			3

201 11

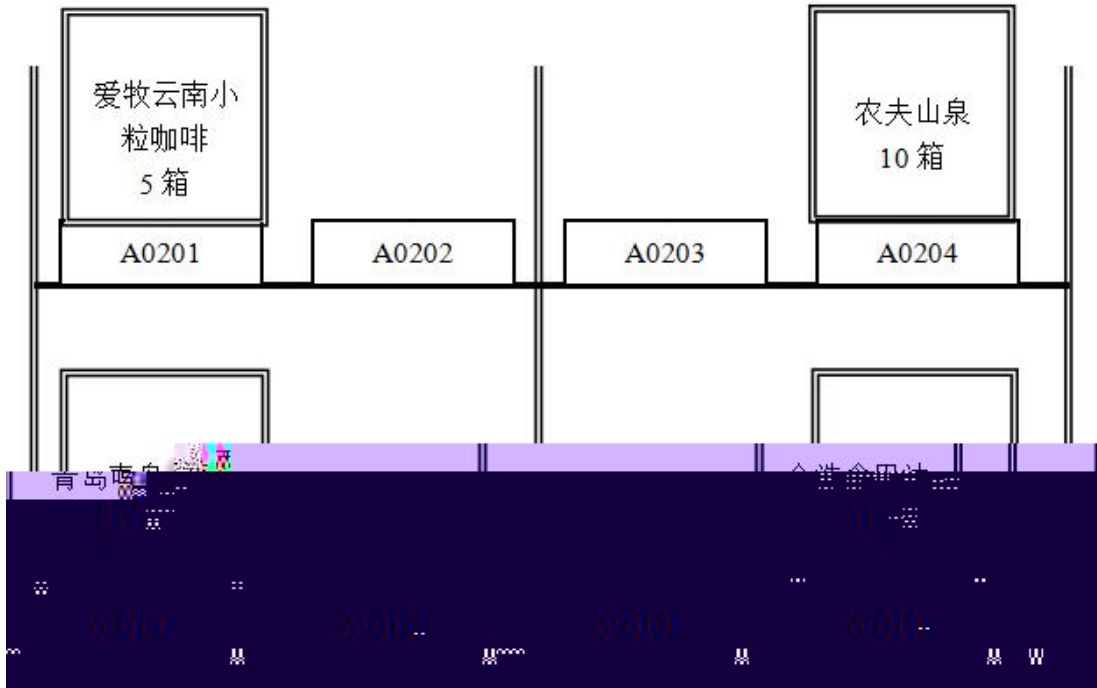
## 产品运输单

	2	1

		5		2	1
				2	
		10		1	2
				2	
		5		2	1
				2	
<b>80</b>		10			2
			6		
			4		
	10			10	3
				1	
	5			5	
					3
5			2		
			2		3
5			1		
				2	
			1		3

		2		2	
				6	1
				2	
		5		3	
			0.5	2	
				6	2
		10		4	
			1 0.5		30
		5			1
				3	1
				4	
			1 0.5		150
		3			3





1 2

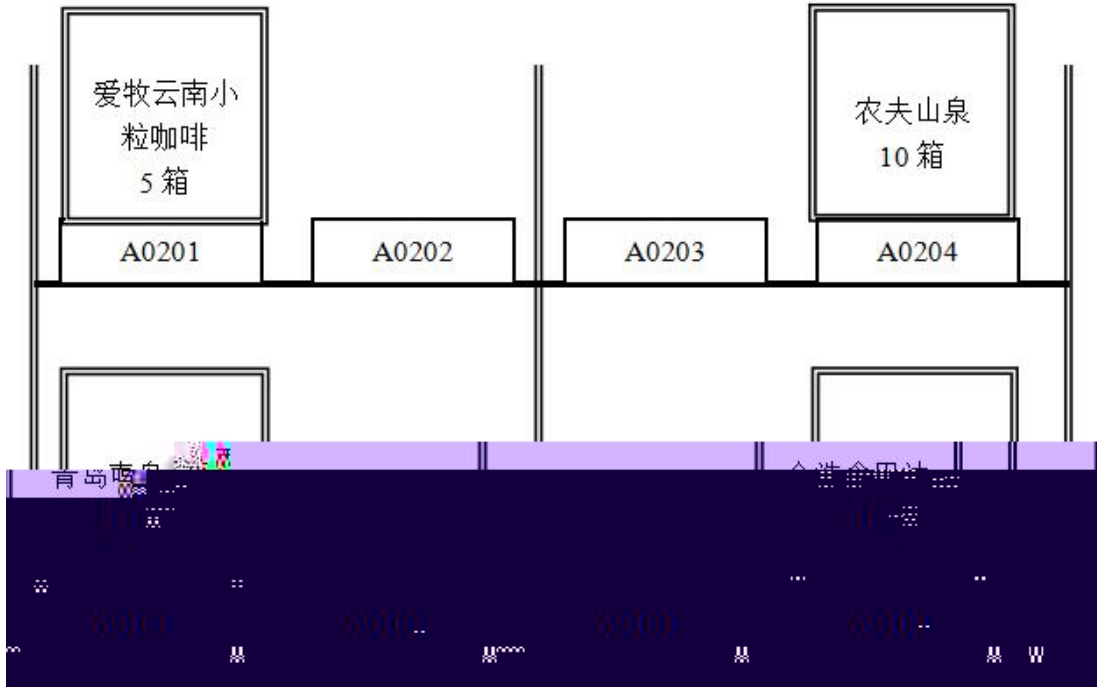

# 产品运输单

1011160001

				310	40		
			40		40		
3			20		20		

○

○

○

○

○

○

○

○

	1	

	2	1

	5		2	1
			2	
	10		1 2 1 2	2
	5		2 2	1
<b>80</b>	10		6	2
			4	
	10		10	3
			1	
	5		5	
	5		3	
	5		2	3
5		1	2	3
			1	2
			1	3

		2		2	
				6	1
				2	
		5		3	
			0.5	2	
				6	2
		10		4	
			1 0.5		30
		5			1
				3	1
				4	
			1 0.5		150
		3			3

201



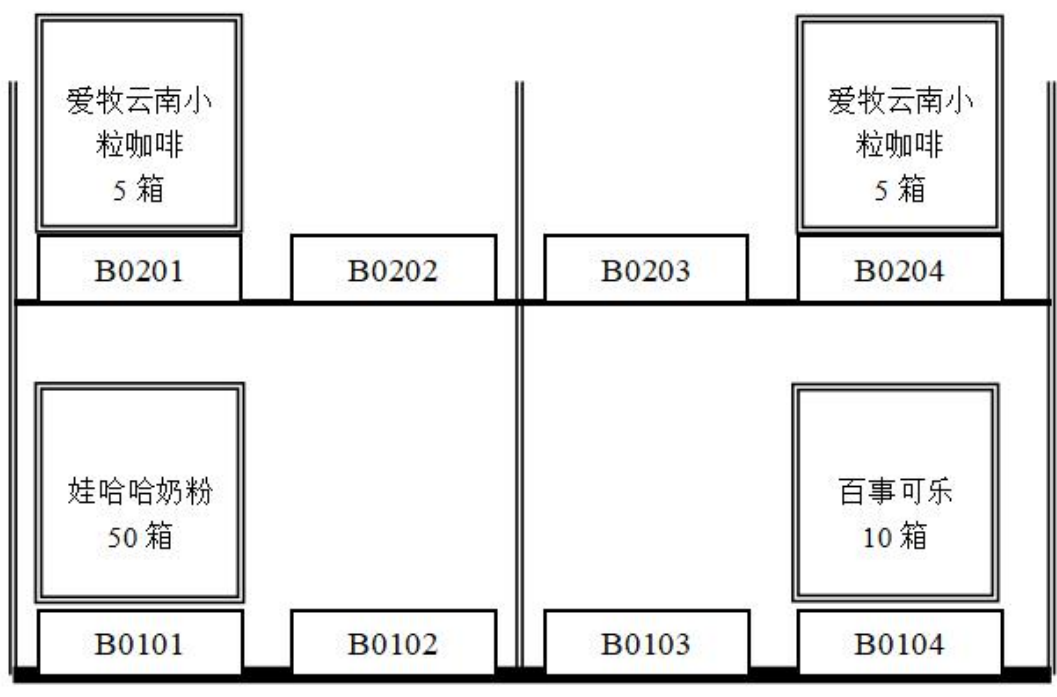
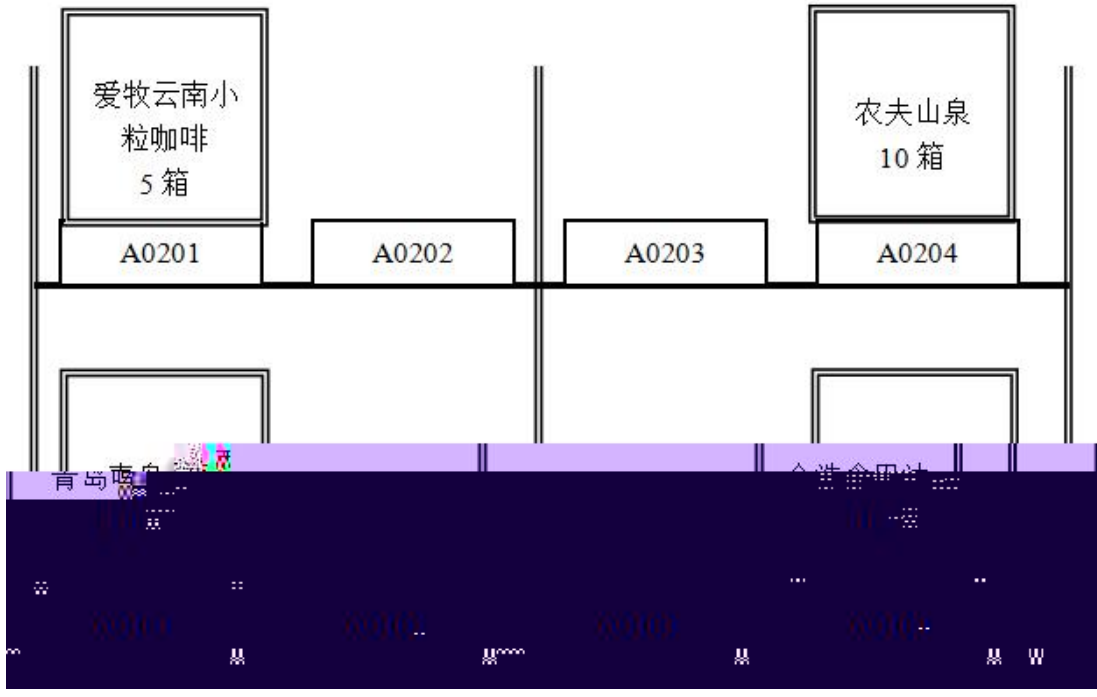

# 产品运输单

1011160001

			20	100 *5	20		
			40	100	40		
			40	330	30		

- 
- 
- 
- 
- 
- 
- 
- 
- 

	1	

	2	1

	5		2	1
	10		2	
	5		2	1
<b>80</b>	10		6	2
	10		4	3
	5		1	
	5		5	
	5		3	
	5		2	3
	5		1	
	5		2	3
		1	3	

		2		2	
				6	1
				2	
		5		3	
			0.5	2	
				6	2
		10		4	
			1 0.5		30
		5			1
				3	1
			1 0.5	4	
					150
		3			3

1

201



1 2

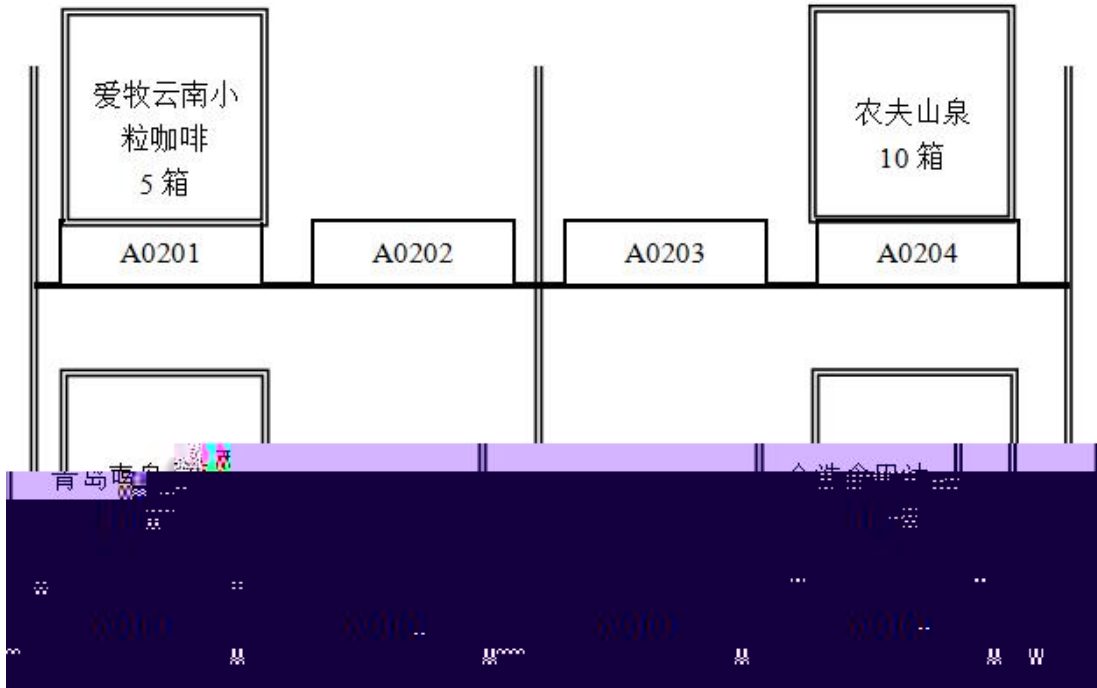

# 产品运输单

1011160001

			40	330	40		
			30	100 *5	30		
			30	310	30		

○

○

○

○

○

○

○

○

	1	



	2	1

		5		2	1
				2	
		10		1	2
				2	
		5		2	1
				2	
<b>80</b>		10			2
			6		
			4		
	10			10	3
				1	
	5			5	
	5				3
			2		
5				2	3
			1		
5				2	
			1		3

		2		2	
				6	1
				2	
		5		3	
			0.5	2	
				6	2
		10		4	
			1 0.5		30
		5			1
				3	1
				4	
			1 0.5		150
		3			3





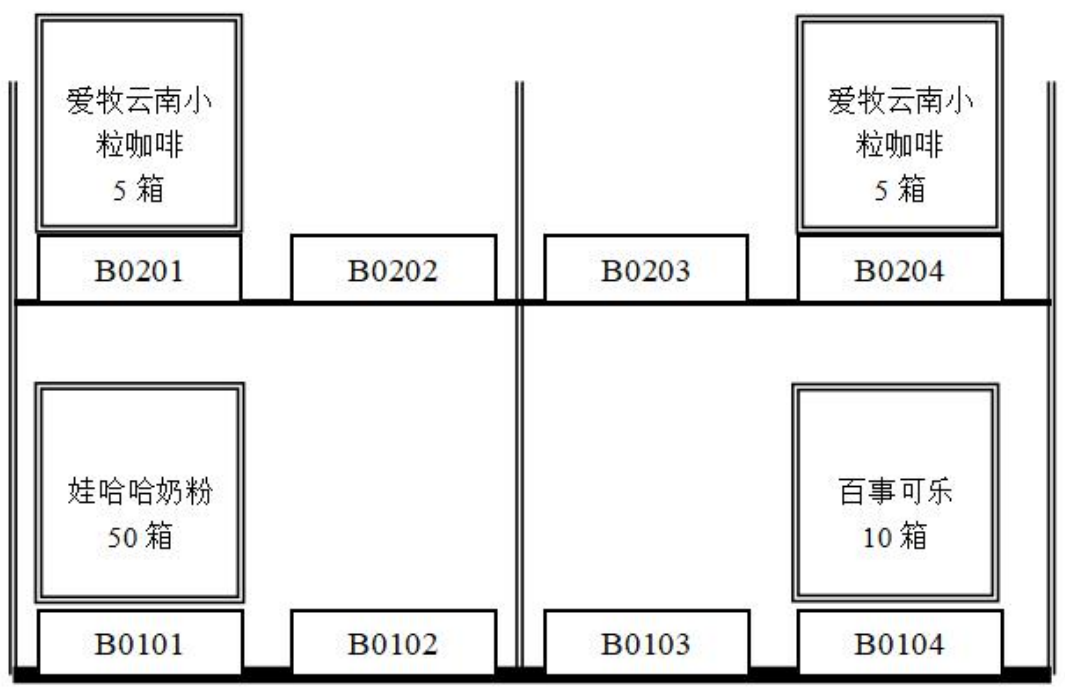
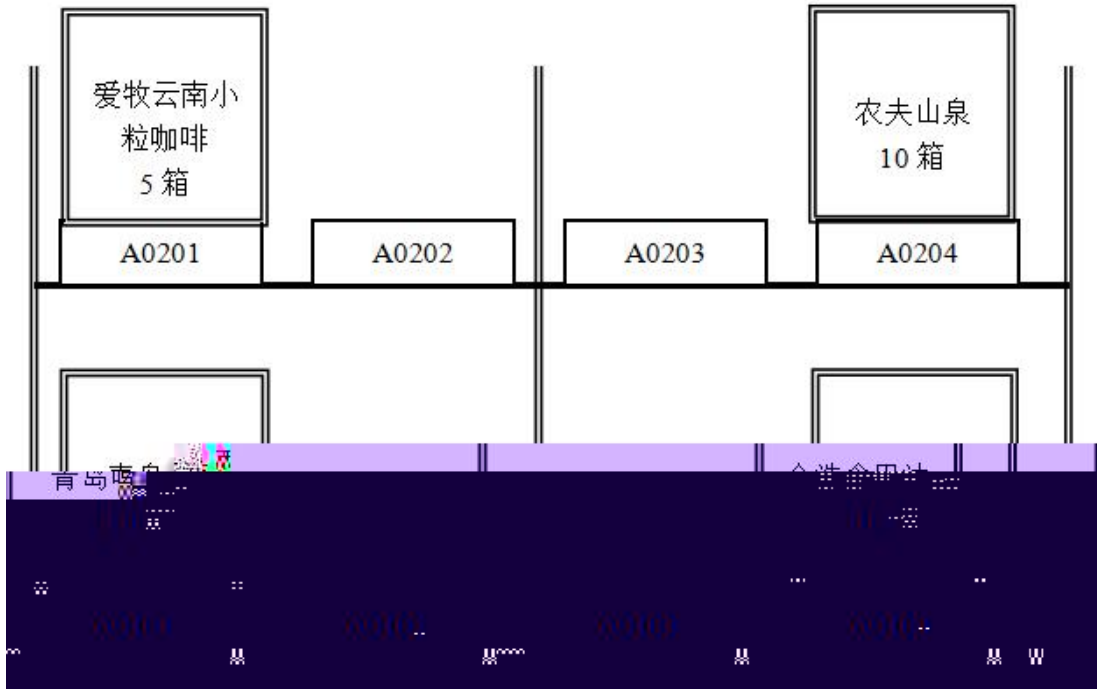

# 产品运输单

1011160001

			40	310	40		
			40	330	40		
3			20	100	20		

- 
- 
- 
- 
- 
- 
- 
- 
- 

	1	

	2	1

		5		2	1
				2	
		10		1	2
				2	
		5		2	1
				2	
<b>80</b>		10		6	2
				4	
	10			10	3
				1	
	5			5	
	5			3	
	5			2	3
5			1		
			2		
			1	3	

		2		2	
				6	1
				2	
		5		3	
			0.5	2	
				6	2
		10		4	
			1 0.5		30
		5			1
				3	1
			1 0.5	4	
					150
		3			3



○

---



---



---

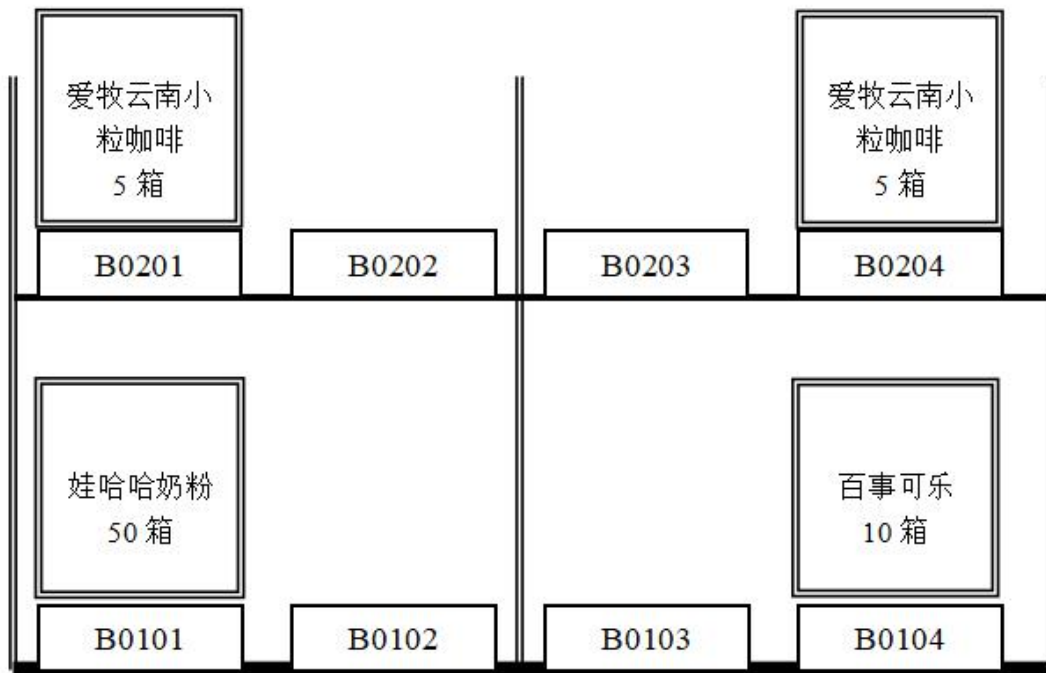
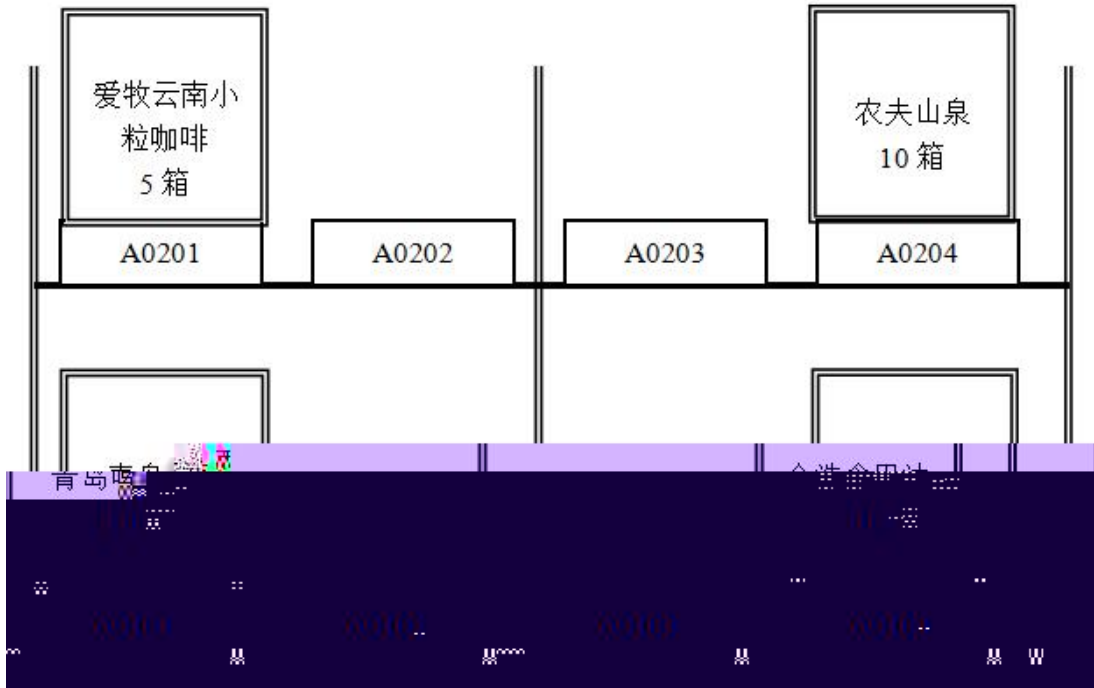



		• IS/AS/W/P @#r P E2A õ Āž

		10		
		10		
		20		
		10		

---



--	--	--	--	--	--

---

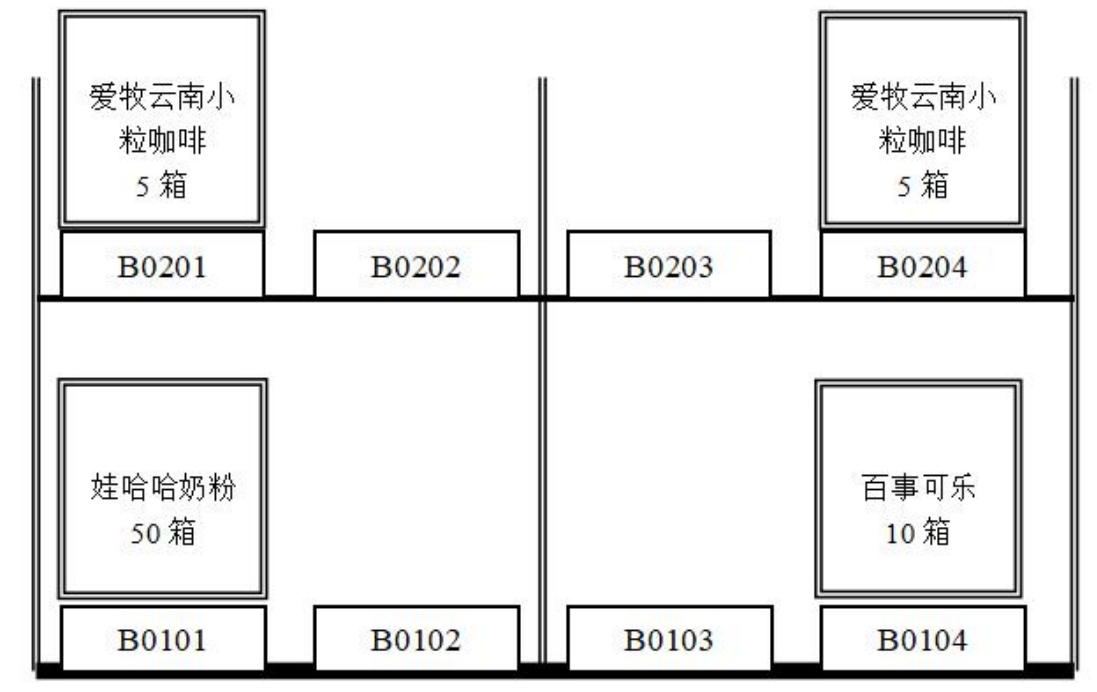
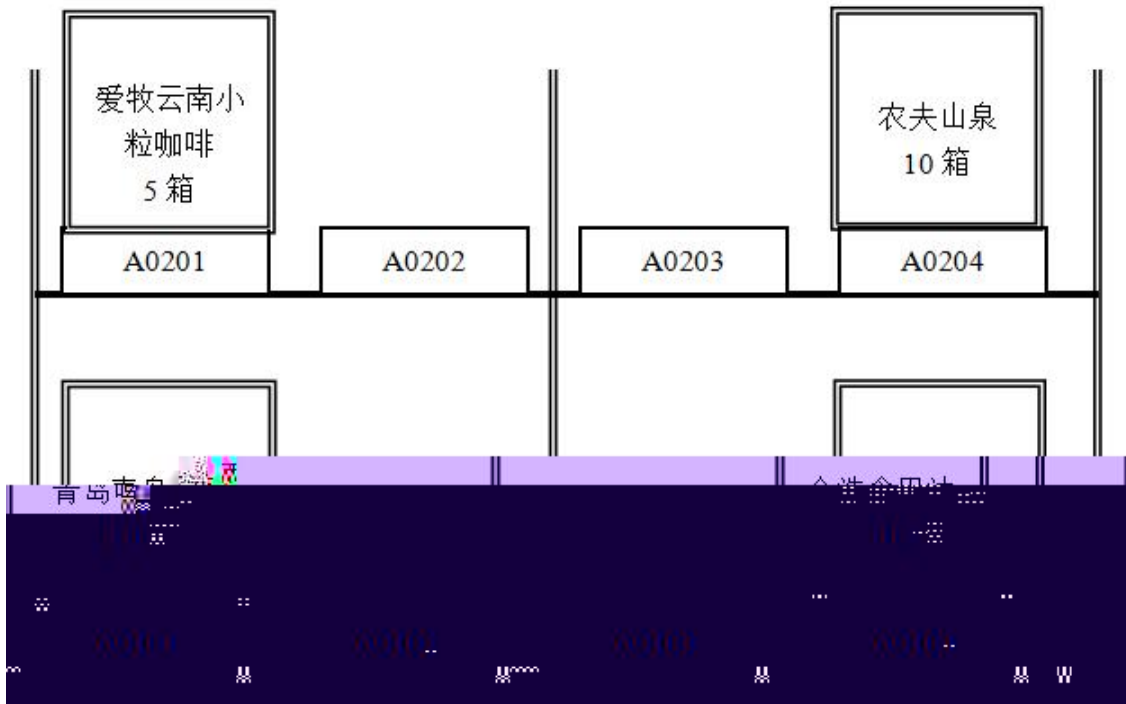

---

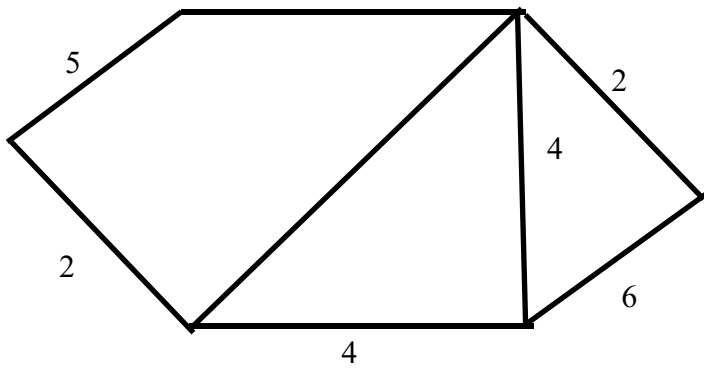





	5			0
	10			
	5			
	5			
	5			
	5			

15

10

10

---



---

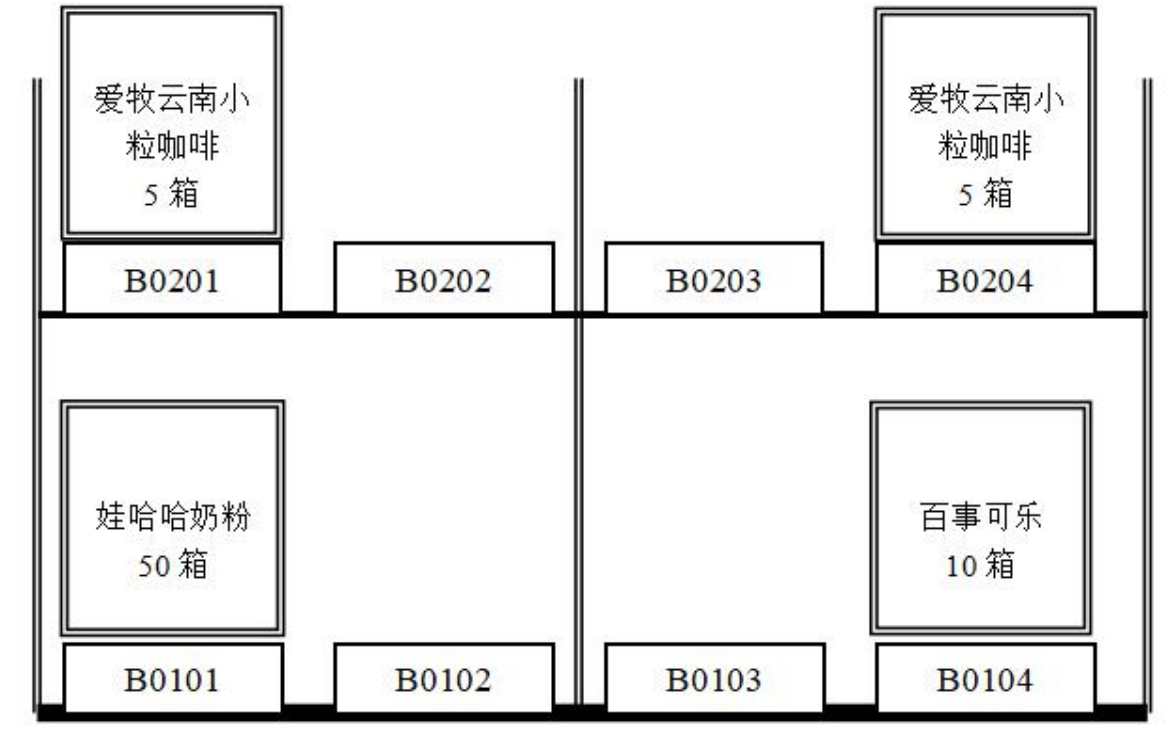
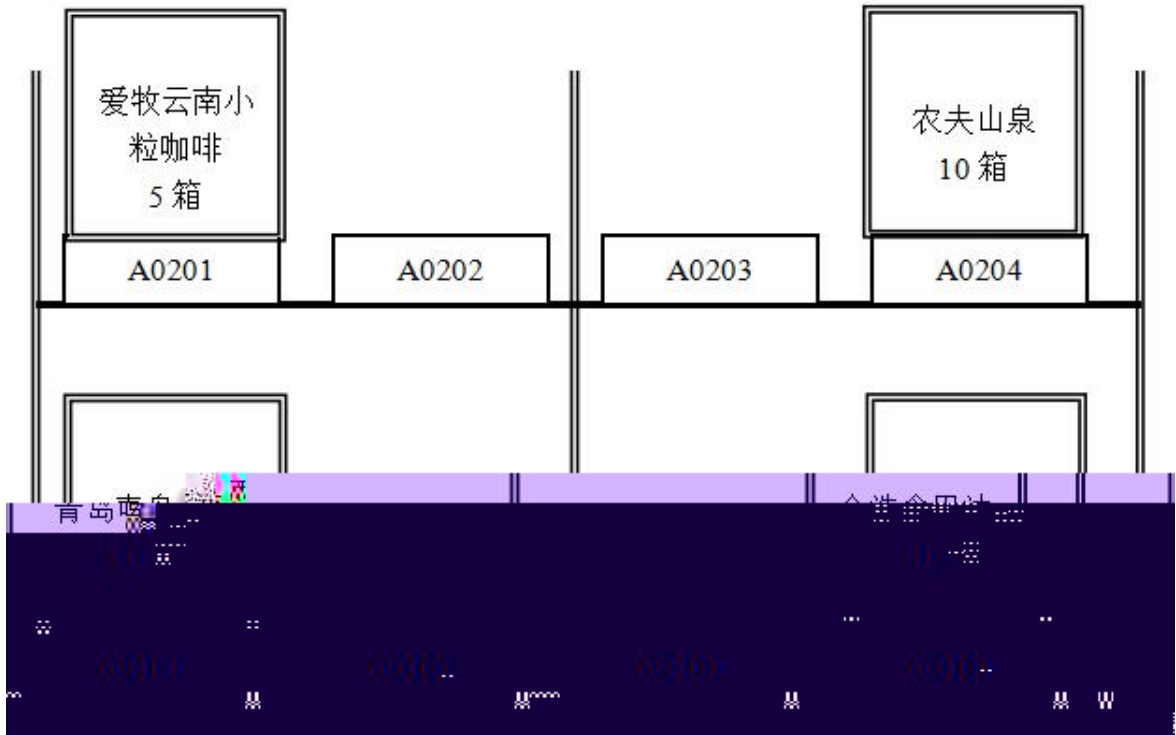

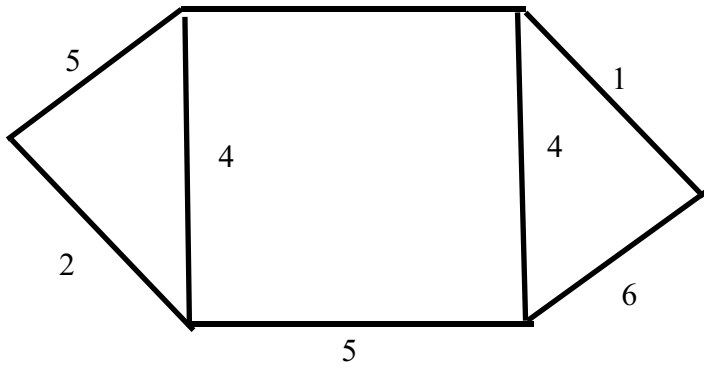

	5			0
	10			
	5			
		5		

		5		
		5		
		15		
		10		
		10		
		20		
		10		

**1**

---



---



---



--- ---



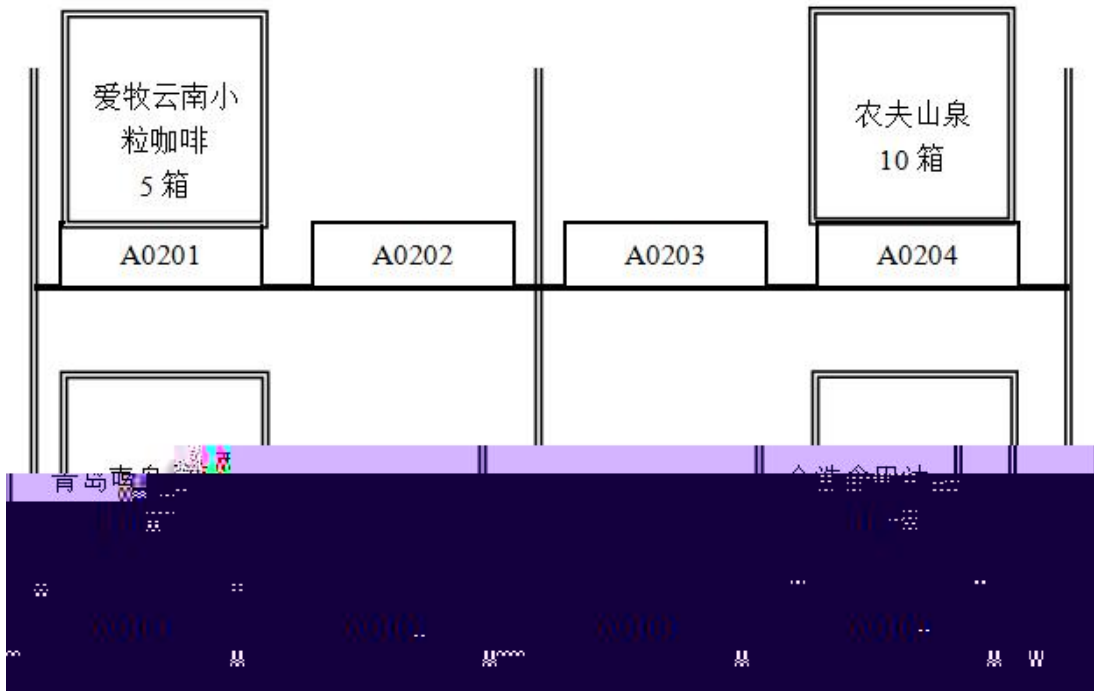

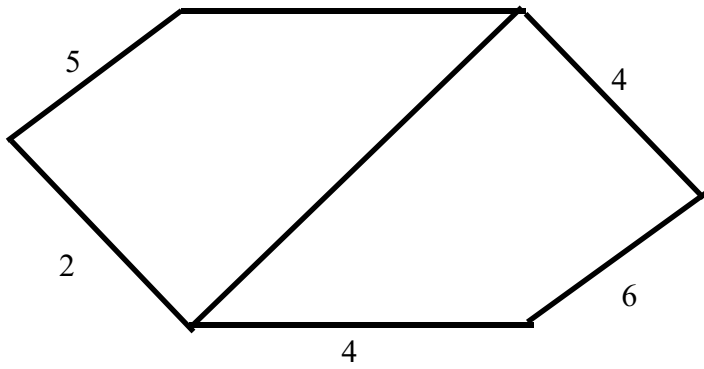



	5			0
	10			
	5			
	5			
	5			
	5			
	15			

		10			
		10			
		20			
		10			

**1**

---



--	--	--	--	--	--

---

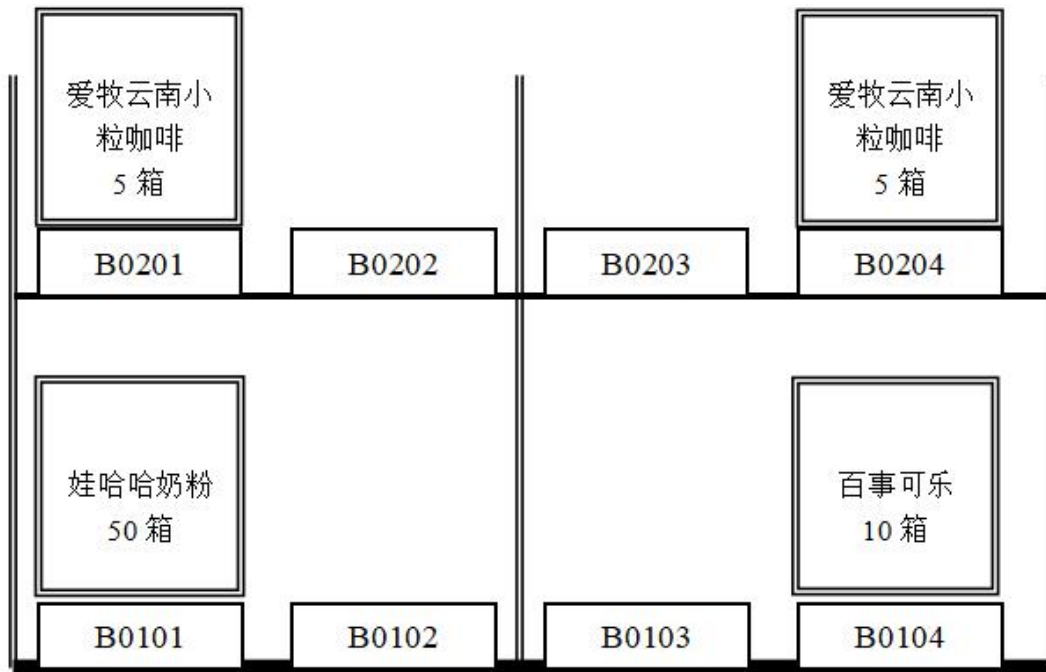
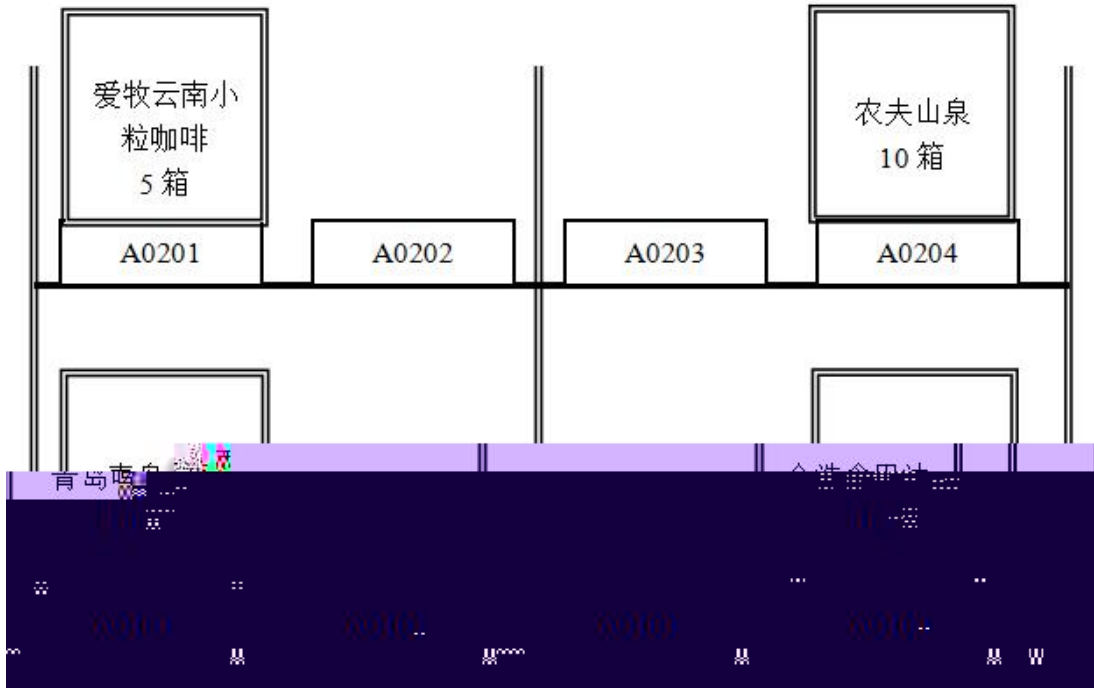

---

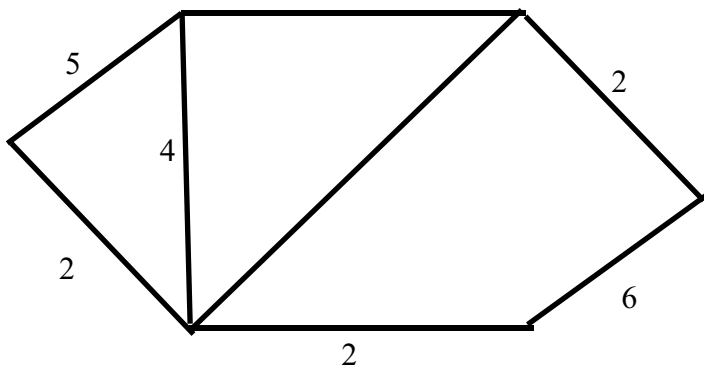



	5			0
	10			
	5			
	5			
	5			



		5			
		15			
		10			
		10			
		20			
		10			





○

○



	5		1	2 2
	10		2	1 2 1 2
	5		1	2 2
	30			0
	15			
	5			
	20			

		10			







○

○



	5		1	2 2
	10		2	1 2 1 2
	5		1	2 2
	30			0
	15			
	5			
20				

		10			



\$

d





○

○



	5		1	2 2
	10		2	1 2 2 1 2
	5		1	2 2
	30			0
	15			
5				
20				

		10			







○

○

--	--







	5		1	2
	10			1
				2
5			2	2
			1	0
	30			
	15			
5				
20				

		10			



✦

○

○



5

		10			



### 三、国际物流作业组织与管理模块

0

À Á Ñ

○



---

---

---

---

---

ΑΝΕΡΩΤΗΜΑΤΑ



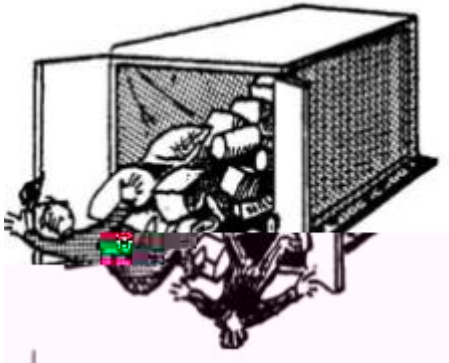
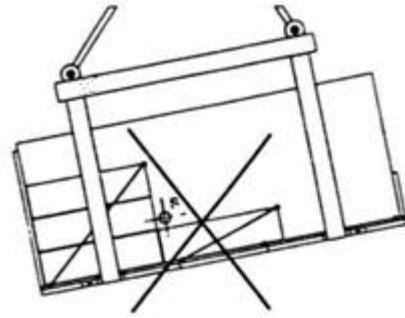



○

船公司	船名/航次	服务代码	航线	装船港/卸船港	启-达日期	天	挂港
Carrier	Voyage	Service	Lane	Load/Unload Port	ETD-ETA	Day	Day
MSC 地中海航运	MASTER HQ409M		中国-香港	HONG KONG 香港 KAOHSIUNG 高雄	02/25(二) 03/15(六)		10
NYK 日本邮船	ITALIAN EXPRES S/024		中国-东南亚	HONG KONG 香港 BANGKOK 曼谷	02/25(二) 03/02(日)		5
CMA-CGM 达飞轮船	CMA CGM GEMINI JTXA49E		中国-非洲	XIAMEN 厦门 DURBAN 德班	02/25(二) 03/27(四)		30
KLINE 川崎汽船	HYUNDAI PLATINUM M/004W		中国-中南美	SHANGHAI 上海 PARANAGUA 巴拉那瓜	02/25(二) 04/09(三)		43
DMS 达源致船	COSCO KAOHSIUNG G/GFS46E		中国-澳新	HONG KONG 香港 NOUMEA 努美阿	02/25(二) 04/02(三)		36
RCL 老海船速	KOTA PERMASAN VPM114		中国-中东/ 波斯湾/印巴	QINGDAO 青岛 MADRAS 马德拉斯	02/28(五) 03/18(二)		18
ZIM 以星轮船	KUO HUNG 311	CHINA_VIETNAM AM(CVX)	中国-港澳台	NINGBO 宁波 HONG KONG 香港	02/25(二) 03/15(六)		18
SAFMARINE 比利时商船	HEIKE P 1404		中国-非洲	KAOHSIUNG 高雄 MINDELO	02/25(二) 04/05(六)		39
CSAV 南美船务	CAP SAN NICOLA S/O1409		中国-中南美	SHANGHAI 上海 RIO GRANDE 里奥格兰德	02/25(二) 04/07(一)		41
OOCL 东方海外	DRESDEN EXPRES S/16E08	Pacific Atlantic (PAX)	中国-美东	SHANGHAI 上海 HALIFAX 哈利法克斯	02/25(二) 04/14(一)		48



○  
○

BEIJING	CN		BJ\$
Y. RENMINBI	CNY		KGS
			1.0000
			1.0000
			1.0000
		100	1.0000
		100	1.0000

				0

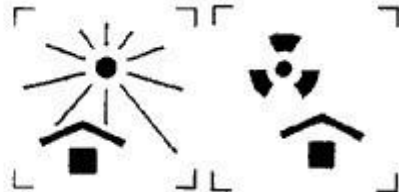

○

				0



○

○







集装箱设备交接单  
EQUIPMENT INTERCHANGE RECEIPT

OUT 出场

No. \_\_\_\_\_

用箱人/运箱人 (CNTR. USER/HAULIER)		提箱地点 (PLACE OF DELIVERY)	
发往地点 (DELIVERED TO)		返回/收箱地点 (PLACE OF RETURN)	
船名/航次 (VESSEL/VOYAGE No.)	集装箱号 (CNTR. No.)	尺寸/类型 (SIZE/TYPE)	营运人 (CNTR. OPTR)
单号 (B/L No.)	危险品类别 (IMCO CLASS)	箱封号 (SEAL No.)	危险货物/非危险货物 (DANGEROUS/NOT DANGEROUS)
货物 (CARGO Wt.)	出场目的/状态 (PPS OF GATE-OUT/STATUS)	进场目的/状态 (PPS OF GATE-IN/STATUS)	出场日期 (TIME-OUT)
当场检查记录 (INSPECTION AT THE TIME OF INTERCHANGE)			
普通集装箱 (GP. CNTR.)	冷藏集装箱 (REF. CNTR.)	特种集装箱 (SPL. CNTR.)	发电机 (GEN. SET)
<input type="checkbox"/> 正常 (SOUND) <input type="checkbox"/> 异常 (DEFECTIVE)	<input type="checkbox"/> 正常 (SOUND) <input type="checkbox"/> 异常 (DEFECTIVE)	设定温度 (SET) <input type="checkbox"/> 记录温度 (RECORDED)	<input type="checkbox"/> 正常 (SOUND) <input type="checkbox"/> 异常 (DEFECTIVE)
损坏记录及代号 (DAMAGE CODE)			
<div style="display: flex; justify-content: space-around;"> <div style="text-align: center;"><b>BR</b> 破损 (BROKEN)</div> <div style="text-align: center;"><b>D</b> 凹痕 (DENT)</div> <div style="text-align: center;"><b>M</b> 缺失 (MISSING)</div> <div style="text-align: center;"><b>DR</b> 污秽 (DIRTY)</div> <div style="text-align: center;"><b>DL</b> 无标 (DGLABEL)</div> </div> <div style="display: flex; justify-content: space-around; margin-top: 10px;"> <div style="text-align: center;">左箱 (LEFT SIDE) </div> <div style="text-align: center;">右箱 (RIGHT SIDE) </div> <div style="text-align: center;">前箱 (FRONT) </div> <div style="text-align: center;">内部 (INSIDE) </div> </div> <div style="display: flex; justify-content: space-around; margin-top: 10px;"> <div style="text-align: center;">顶部 (TOP) </div> <div style="text-align: center;">底部 (FLOOR BASE) </div> <div style="text-align: center;">后箱 (REAR) </div> <div style="text-align: center;">如有异常, 请注明程度及尺寸 (REMARK)</div> </div>			
除列明者外, 集装箱设备交接时完好无损, 箱封完整无误。 EQUIPMENT INTERCHANGED IN SOUND CONDITION AND SEAL INTACT UNLESS OTHERWISE STATED		CONTAINER EQUIPMENT USER/HAULIER SIGNATURE	
用箱人/运箱人签署 (CONTAINER USER/HAULIER'S SIGNATURE)		码头/堆场值班员签署 (TERMINAL/DEPOT CLERK'S SIGNATURE)	
_____ 日		_____ 年 _____ 月 _____ 日	

GB/T 16561—1996 格式印刷

				0







				0

--	--	--	--	--	--



				0



				0



				0







--	--	--

				0

--	--	--	--	--	--





--	--	--	--	--	--

--	--	--	--	--	--	--	--

○







				0

○

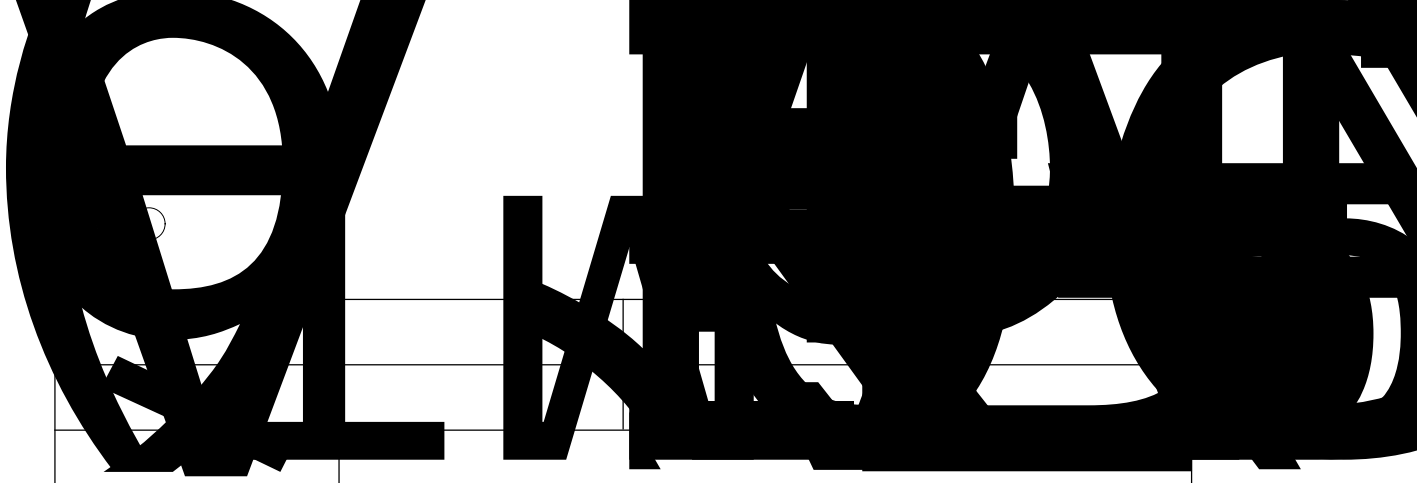

○	■ ■



				0

PROPOSIZIONE  
VANTAGGI





					0

○

--	--	--

				0



				0





				0

--	--	--	--	--	--

○

○

○

0

○

				0



				0

#### 四、 快递物流作业组织与管理模块























--	--	--	--	--	--

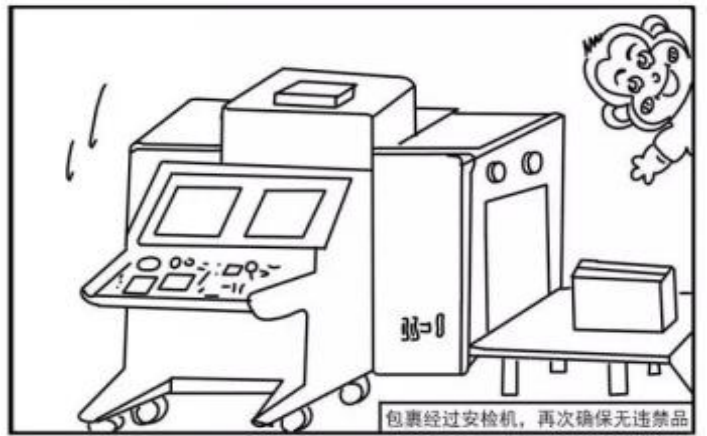



--	--	--	--	--	--

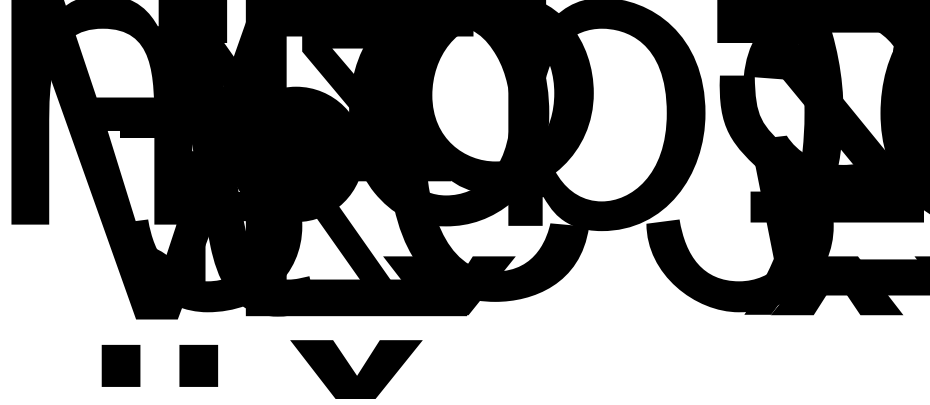
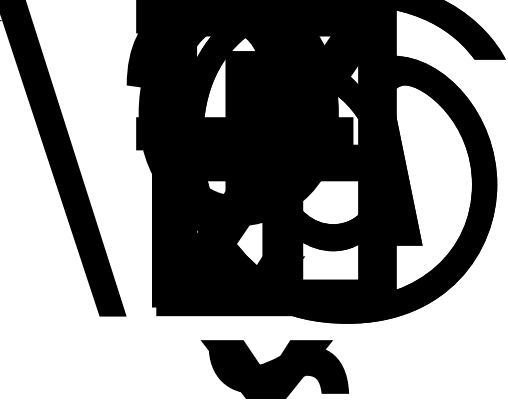

@B0r\$@

È ) : #§ 8





--	--	--













--	--	--	--	--	--



[想知道:中国成都理工大学校园快递具体在哪? 百度知道](#)

3个回答 - 提问时间: 2014年02月10日

最佳答案:韵达在银杏后面。宝盒、圆通、顺丰在电影院后面。中通、申通在图书馆下面。常用的是这几个。

[zhidao.baidu.com/link?... 2014-02-15](#) - 百度快照 - 80%好评



















--	--	--	--















--	--	--	--











	$i\lambda$	

































































--

